



Warn Industries, Inc.

12900 S.E. Capps Rd. • Clackamas, Oregon 97015 • USA
503-722-1200 • International Fax: 503-722-3005

Operator's Manual
for the

**CE M6000
WINCH**



As you read these instructions, you will see NOTES, CAUTIONS and WARNINGS. Each message has a specific purpose. NOTES are additional information to help you complete a procedure. CAUTIONS are safety messages that indicate a potentially hazardous situation which, if not avoided, may result in minor or moderate injury. A CAUTION may also be used to alert against unsafe practice. WARNINGS are safety messages that indicate a potentially hazardous situation, which, if not avoided could result in serious injury. CAUTIONS and WARNINGS identify the hazard, indicate how to avoid hazard, and advise of the probable consequence of not avoiding the hazard. PLEASE WORK SAFELY!

CE M6000
SELF-RECOVERY PN 458802

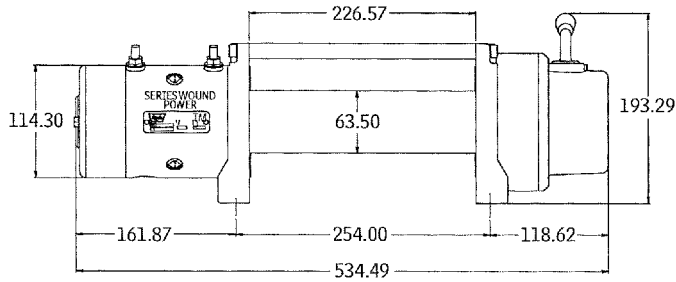

534mm L. x 160mm D. x 193mm H.
 Mounting Bolt Pattern: 254mm x 114.3mm



12V dc PERFORMANCE SPECS

1ST LAYER OF DRUM	0	14.78	85
	907	7.22	175
	1814	3.93	360
	2722	3.05	465
LINE PULL	LINE SPEED	MOTOR CURRENT	
KGS	M/MIN	AMPS	

SPECIFICATIONS

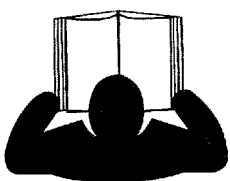
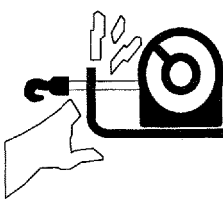

PART NUMBER	458802 (12V DC, Roller fairlead)
RATED LINE PULL	2722 kgs. (single-line)
MOTOR	3.6 KW
GEAR RATIO	156:1
LUBRICATION	Molylube #1 or Aeroshell #17
CLUTCH [FREESPOOLING]	Sliding Ring Gear
BRAKE	Automatic Direct Drive Cone
DRUM DIAMETER/LENGTH	6.4cm/23cm
WIRE ROPE	24M, 8mm diameter
CONTROL	Remote switch, 3.7M
REMOTE CONTROL	Included
RECOMMENDED BATTERY	650 CCA minimum for winching
BATTERY LEADS	2 GA. 1.83M
WEIGHT	34 kgs.
FAIRLEAD	Roller
FINISH	Argent Powder Coat
SOUND EMISSIONS AT 2.5	70dBa
INTERMITANT DUTY RATING	
RUN TIME @ RATED LOAD	30 sec.
COOL DOWN TIME	10 minutes

SAFETY PRECAUTIONS

 WARNING		
		
MOVING PART HAZARD		
<ul style="list-style-type: none">■ To prevent serious injury and property damage:■ Do not operate or install winch without reading and understanding the operator's manual.■ Keep hands clear of wire rope, hook and fairlead opening during operation and when spooling.■ Stand clear of wire rope and load during operation.■ Keep others away.■ Inspect winch installation and wire rope condition before operating winch.■ Do not exceed winch's rated capacity.■ Never touch wire rope or hook while in tension.		

APPLICATION INFORMATION

 WARNING	
	
<p>To prevent serious injury:</p> <ul style="list-style-type: none">■ Do not use as a hoist■ Do not use to move persons	

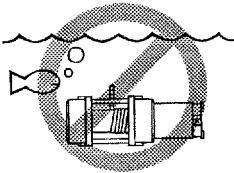
 CAUTION	
	
<p>To avoid injury and property damage:</p> <ul style="list-style-type: none">■ Do not use winch to secure a load during transport■ Do not submerge in water	

- **This is a winch, not a hoist.** Use only to slide loads. Never lift a load by the winch.
- Maximum single line pulling capacity : 2722 KG.
- Intermittent duty rating: 30 second run time @ rated load; 10 minute cool down time.
- 12 Volts DC.

INSTALLATION INSTRUCTIONS

(ONLY USE CE APPROVED MTG. KITS PER 74/483/EEC EUROPEAN DIRECTIVE)



CAUTION

Disconnect from its power source when not in use with power interrupt switch.

WINCH INSTALLATION

- Choose a mounting location that is sufficiently strong enough to withstand the loads you intend to winch.
- Only the mounting orientation shown is possible for safe winching operation. All others are improper and inappropriate.
- In either orientation, the wire rope must always spool onto the drum as indicated by the drum rotation decal.
- The use of recommended bolt and lock washer combinations torqued to recommended levels will prevent vibration during operation.

- ① MOUNTING LOCATION
SMOOTH AND FLAT, THICKNESS = 1/4" (6.4MM)

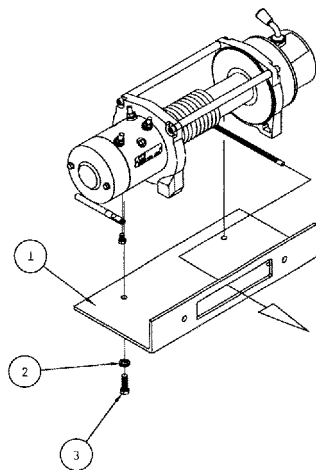
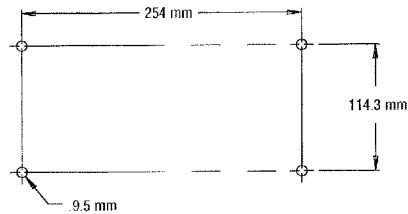

- ② 3/8 LOCKWASHER X 4
③ 3/8 - 16 X 1 1/4" LONG, GRADE 5 BOLT X 4 TORQUE 30-35 FT. LBS.

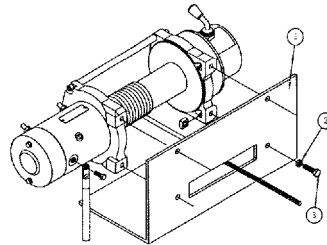

SOLENOID PACK INSTALLATION



CAUTION

- Do not leave remote control plugged into winch while freespooling, rigging, or sitting idle.
- Before winching, inspect remote control lead for damage.
- When using remote control inside a vehicle, always pass it through a window to avoid pinching lead in door.
- Store the remote control in a protected, clean, dry area.

- Mount the control pack according to instructions and with bracket included in the Warn mounting system. To mount control pack directly to winch, order control pack bracket part number 26368.

ELECTRICAL CONNECTIONS

- Make sure to use the insulating boots on the exposed connections to prevent electrical shorting. Route battery connection cables in areas which will not cause them to chafe or cut through the insulation causing a potential short circuit.
- Upon completion of installation, check winch for proper operation.

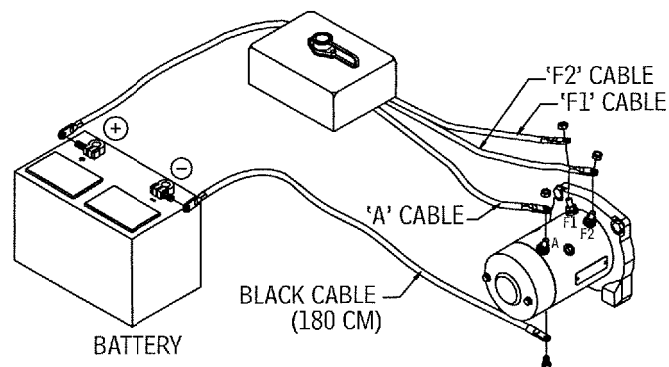

ELECTRICAL CIRCUIT DIAGRAM

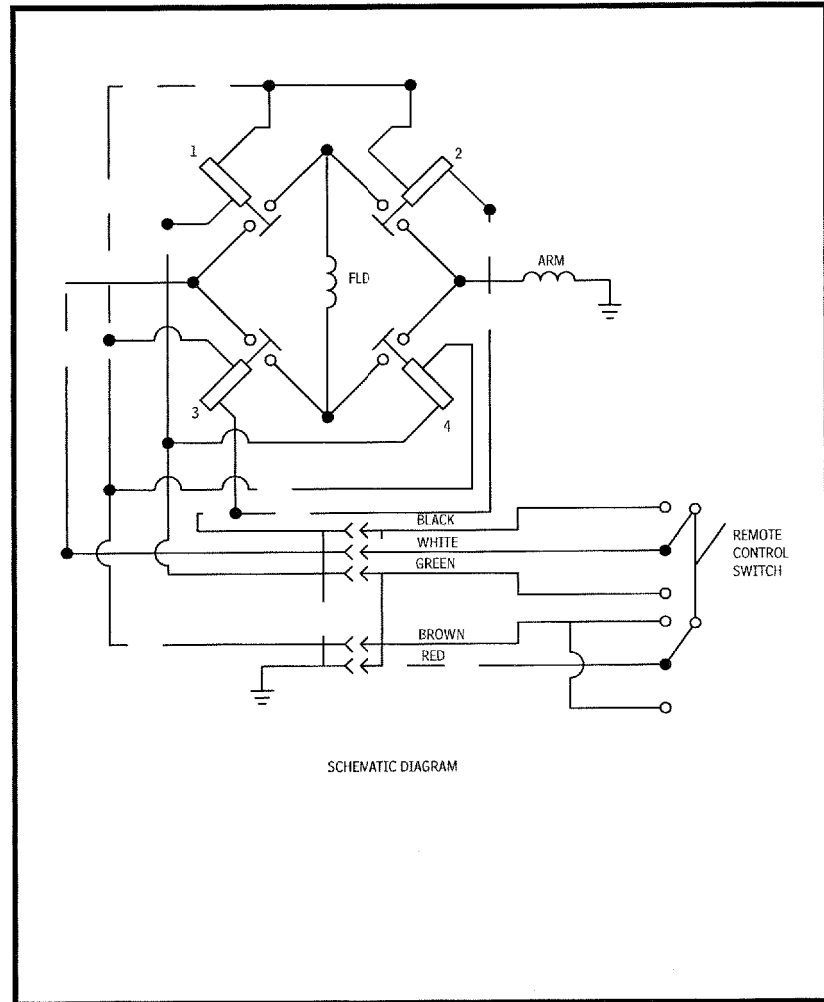

OPERATING INSTRUCTIONS

	CAUTION
<p>KNOW YOUR WINCH: Take time to fully understand your winch and the winching operation.</p>	

REMOTE CONTROL SWITCH

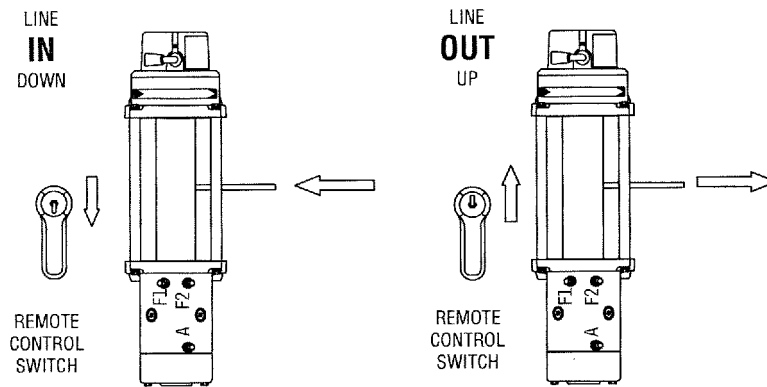

CLUTCH OPERATION

 WARNING
To prevent serious injury and property damage: <ul style="list-style-type: none">■ Do not disengage clutch if winch is under load or wire rope is in tension.

When the clutch is engaged the gear train is coupled to the wire rope drum and power may be transferred from the winch motor. When the clutch is in free spool the gear train and wire rope drum are uncoupled allowing the drum to rotate freely. The clutch knob, located on the winch housing opposite the motor, controls the clutch position. To prevent damage, always fully engage or fully disengage the clutch knob.

OVERLOADING/OVERHEATING

This winch is rated for intermittent duty. When the motor approaches stall speed, very rapid heat buildup occurs which may cause motor damage.

Double-line rigging (see Rigging section) will reduce the amperage draw, and reduce heat buildup in the motor. This allows longer continual use.

OPERATOR'S SAFE WORKING STATIONS

The operator should always operate the winch in a safe position while pulling a load. The safe areas are perpendicular to the wire rope or in the vehicle with the hood up (if winch is mounted on front of vehicle). This will help prevent the wire rope from striking the operator if it fails under load. Operate the winch, when possible, at the end of the remote control length. The operator must be at least 8 ft (2,4m) from the winch while operating. This will prevent entanglement with the fairlead and keep the operator out of harms way during winch load pulling. **Never work around wire rope while under load.**



BATTERY RECOMMENDATIONS

A fully charged battery and good connections are essential to the proper operation of your winch. The minimum requirement for a 12 volt DC battery is 650 Cold Cranking Amperes.

MAINTENANCE

- No lubrication is required for the life of the winch, unless the winch is submerged in water. If this occurs, a qualified service center must complete service as soon as possible to prevent corrosion damage. If the control pack is submerged, it must be replaced when the winch is serviced.
- Check battery cables and electrical connections at 90 day intervals to be certain they are clean and tight at all connection points.
- Inspect the wire rope before and after each winching operation. Replace when damaged.
- The wire rope must always spool onto the drum as indicated by the drum rotation decal on the winch.

WINCHING

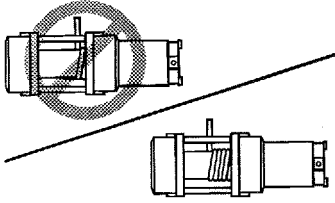
 CAUTION	
	
<p>To avoid injury and property damage:</p> <ul style="list-style-type: none">■ Wear heavy leather gloves when handling the wire rope.■ Never winch with less than 5 wraps of wire rope around the drum.	

SPOOLING

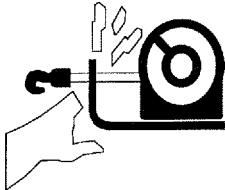
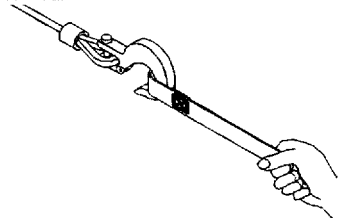
 WARNING	
	
<p>To prevent serious injury:</p> <ul style="list-style-type: none">■ Keep hands clear of wire rope, hook and fairlead opening during operation and when spooling.■ Use supplied hook strap for spooling wire rope.	

STRETCHING WIRE ROPE

- The life of a wire rope is directly related to the use and care it receives. During its first use, a new wire rope must be spooled onto its drum under a load of at least 500 lb. [227 KG]. Spool out the wire rope to the last 5 wraps on the drum, then power in the wire rope under a load of 500 lb. [227 KG] or more. This will stretch new wire rope and create a good wire wrap around the drum. Failure to do so will result in the outer wire wraps drawing into the inner wraps, binding, and damaging the wire rope.

SPOOLING OUT

- Freespooling is generally the quickest and easiest way to spool out wire rope. Before freespooling wire rope out from the winch, power out enough rope to remove any tension the wire rope may be under. Disengage the clutch. Now freespool by manually spooling out enough wire rope for the winching operation. Always leave at least 5 wraps on the drum.

SPOOLING IN UNDER LOAD

- Power in the wire rope evenly and tightly on the drum. This prevents the outer wire wraps from drawing into the inner wraps, binding, and damaging the wire rope.
- Avoid shock loads when spooling, by using the control switch intermittently to take up wire rope slack. Shock loads can momentarily far exceed the winch and wire rope ratings.

SPOOLING IN UNDER NO LOAD

- *Assisted* - Have your assistant hold the hook with the hook strap putting as much constant tension on the wire rope as possible. While keeping tension, the assistant should walk toward the winch while you operate the control switch spooling in the wire rope. **Release the switch when the hook is a minimum of 8 ft [2,4 m] from the fairlead opening. Spool in the remainder for storage.**

- *Unassisted* - Arrange the wire rope to be spooled so it will not kink or tangle when spooled. Be sure any wire rope on the drum is tightly and evenly layered. Spool enough wire rope to complete the next full layer on the drum. **Tighten and straighten the layer. Repeat process until the hook is a minimum of 8 ft [2,4 m] from the fairlead.** Spool in the remainder for storage.



SPOOLING REMAINDER FOR STORAGE

- Secure the hook to a suitable anchor point near the winch. Carefully power in the remaining wire rope, jogging the control switch to take up the last of the slack. Be careful not to over tighten or damage may occur to the wire rope or anchor point.

SOUND EMISSIONS

- The winch is designed so that the sound emissions do not exceed 70 dBa from the operator's station. The operator must be at least 8 ft. (2,4m) from the winch while operating. If the winch is exceeding 70 dBa from the operator's station, have it inspected at an authorized service center.

RIGGING

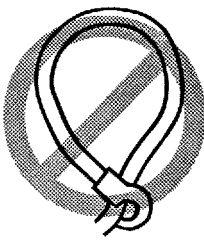
 WARNING		
		
<ul style="list-style-type: none"> ■ Stand clear of wire rope and load during operation. ■ Be certain the anchor you select will withstand load. ■ Never wrap wire rope back onto itself. ■ Use a choker chain, wire choker rope or tree trunk protector on the anchor. ■ Prior to initiating winching operation be sure any element which can interfere with safe winching operations is removed. ■ Take your time. Sloppy rigging causes accidents. 		

- Always spool out as much wire rope as possible while leaving the last 5 wraps on the drum. Pick an anchor as far away as practical. This provides the winch with its greatest pulling power.

- Approximate pulling power:

Pulling Power	Wire Rope Layer
2722 kg	1st layer*
2477 kg	2nd layer
2268 kg	3rd layer
2118 kg	4th layer

*closest to drum core

- Rigging a double line with a snatch block will reduce the load on the winch in half without significant loss of spooling speed.

- Natural anchors such as trees, stumps and rocks are the handiest when available. Attach the choker chain, wire choker rope or tree trunk protector on the anchor as low as possible to avoid pulling the anchor down. If several possible anchors are available but they are not strong enough individually, it may be practical to attach a wire or chain choker around several anchors to form a strong collective anchor point.
- Some of the most commonly used riggings are shown below:

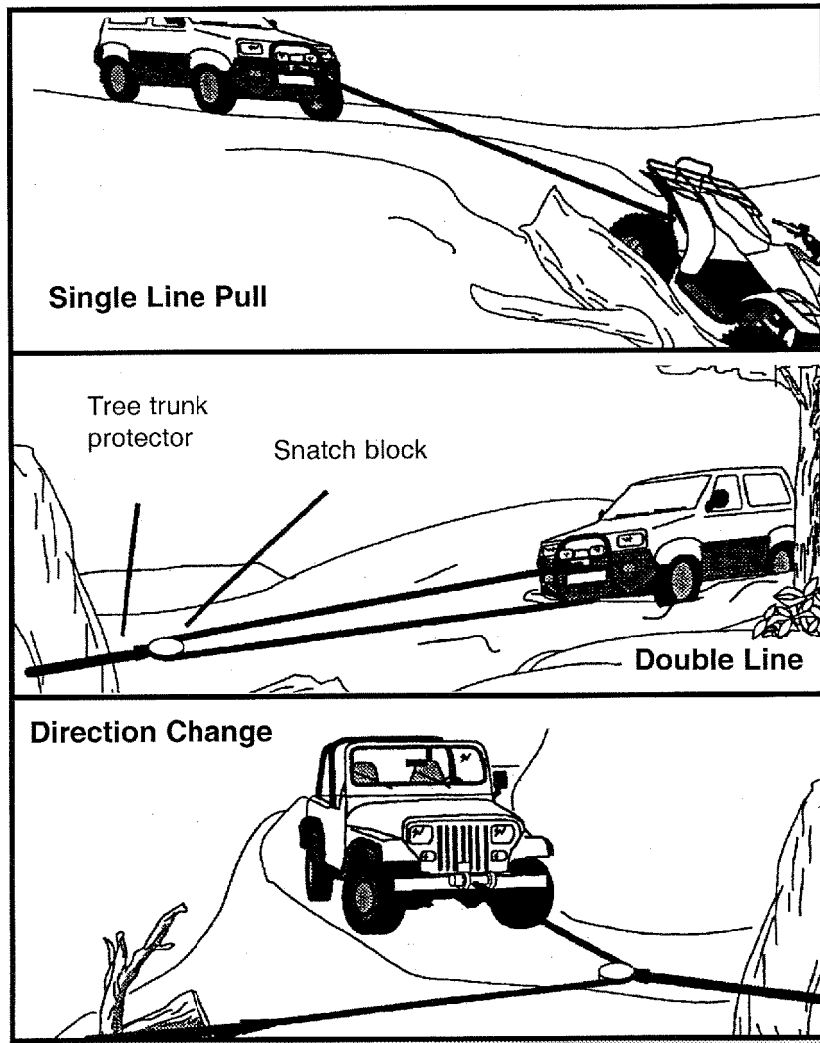

Note: Authorized service centers will need the date of manufacture, date code and serial number in order to service winch properly. This information is located on the geartrain end of winch (closest to clutch handle).

Model #: _____

Date of Manufacture: _____

Date code: _____

Date of purchase: _____

Place of purchase: _____